

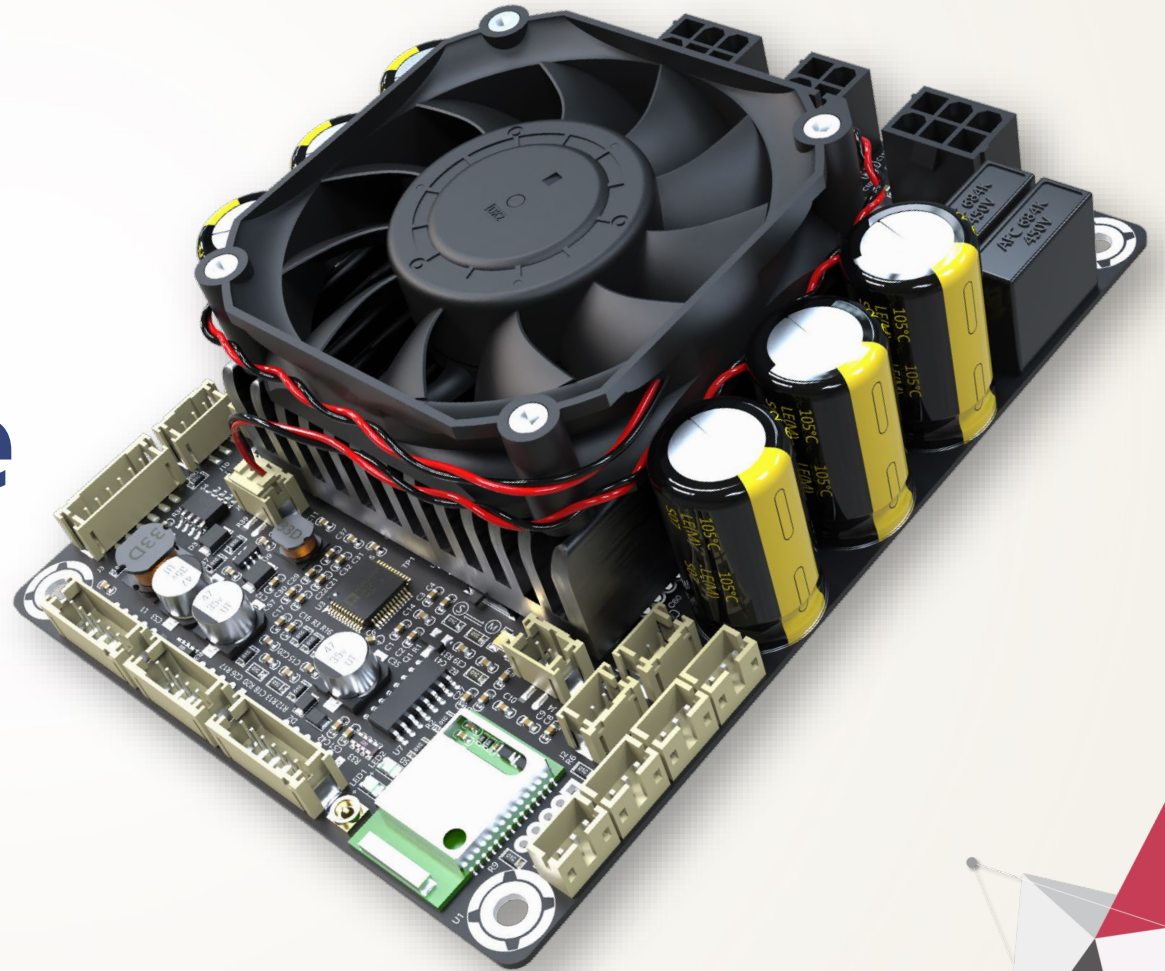

# JAB5 Connection Guide

---

BY SURE ELECTRONICS CO., LTD.





# What is JAB5?

JAB5 is a four-channel audio amplifier board integrated with high performance Bluetooth 5.0 (Supporting APT-X HD) and ADAU1701 DSP, which delivers 100W per channel into a 60Ohm load. With employed signal level sensor system and power management system, JAB5 features low power consumption and high efficiency, suitable **for home audio, DIY audio, Bluetooth speakers and digital crossover applications.**

JAB5 supports Bluetooth input, line input and I2S input. Signal would be mixed and delivered to speaker output.



Portable  
Bluetooth Speaker



Home  
Audio



Car  
Audio



DIY  
Applications



Digital  
Crossover

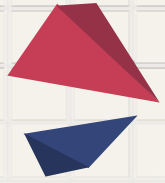

## What is JAB5?

**JAB5 supports 4.0 mode (4 x 100W), 2.1 mode (2 x 100W + 1 x 200W) and 2.0 mode (2 x 200W).** The switch between the three modes are achieved by automatic cables identification, without any need of other operations. Furthermore, JAB5 supports cascading with another JAB5 to get 8 x 100W or other audio systems through the I2S output port.

Four ports are provided for external potentiometers to control the volume, gain and frequency. With the connection of ICP3 or higher version(s), customers can achieve programming DSP through SigmaStudio or remote control with APP or PC UI.

### Key Features:

- **Integrated with Qualcomm/CSR QCC 3034, Bluetooth V5.0 w aptX HD & ADAU1701 DSP**
- **Supporting I2S input, line input, I2S output**
- **Supporting programming with SigmaStudio or remote control via APP or PC UI**
- **Cascadable with another JAB5 to build an 8.0 Audio System**

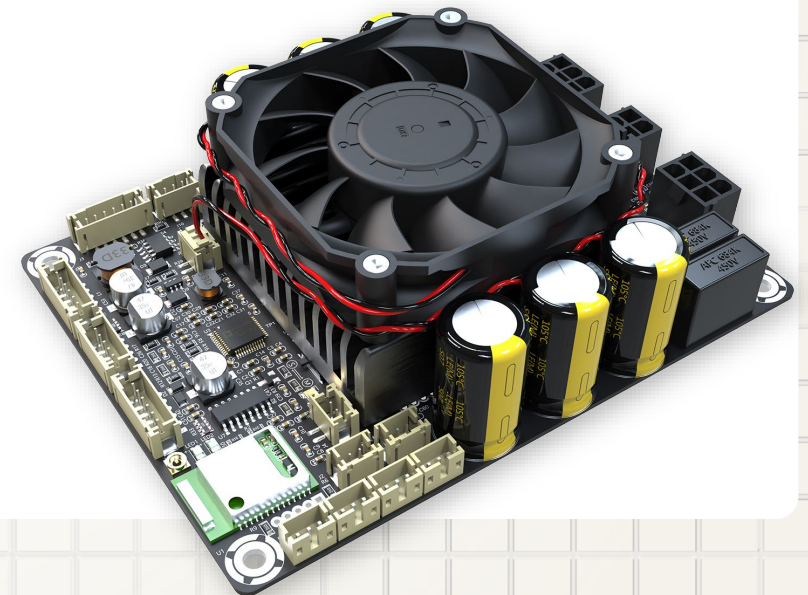

# Block Diagram

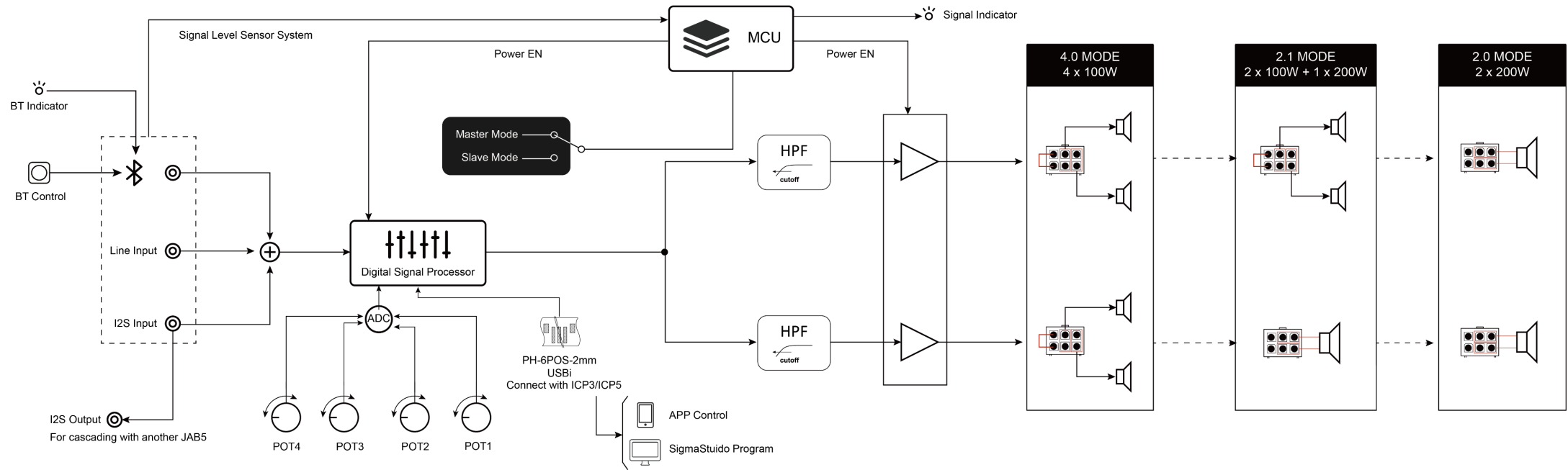

The switch between 4.0 mode, 2.1 mode and 2.0 mode is achieved by automatic cable identification. JAB5 can be cascading with another JAB5 to get an 8 x 100W system.

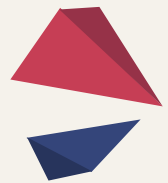

# Connection Diagram

## Speaker Output

JAB5 supports PBTL mode, each 2 channels can be configured as one channel with double power.

The switch of the output mode is based on cables identification circuit and the settings is as follows.

### BTL MODE

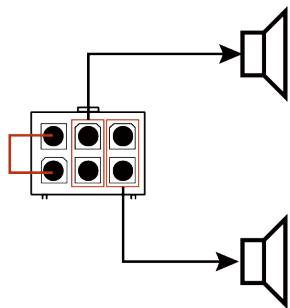

### PBTL MODE

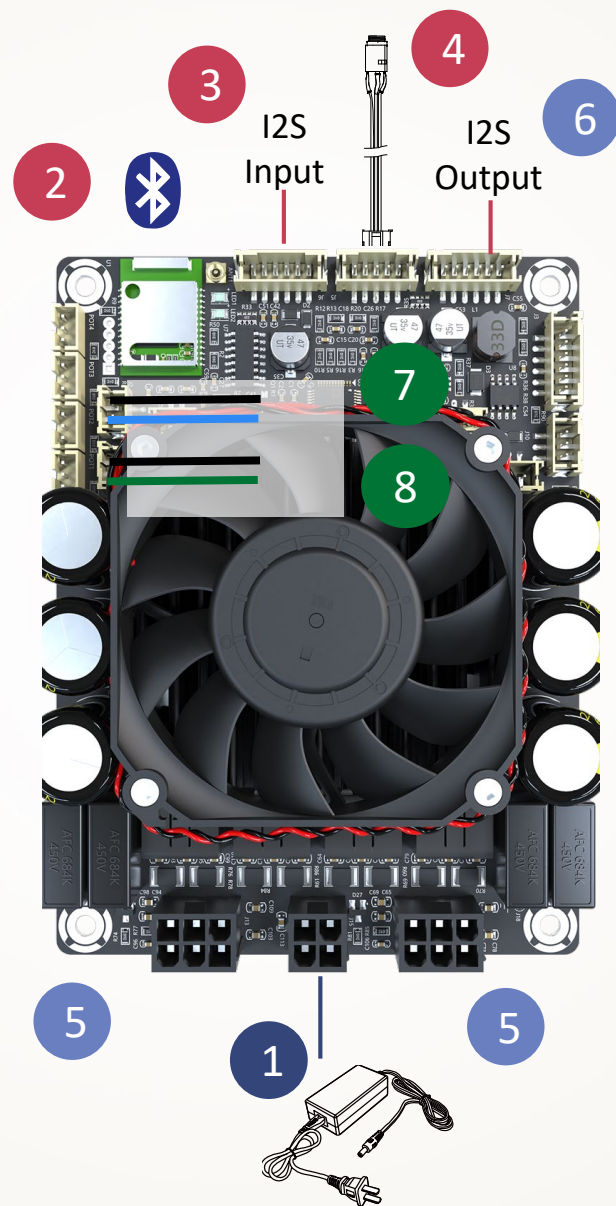
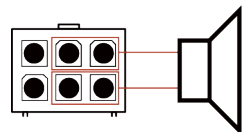

## Power Supply

- 1 DC10V-39V power supply

## Audio Input

- 2 Bluetooth 5.0 module
- 3 I2S Input
- 4 Analog Line Input

## Audio Output

- 5 Stereo speaker output
- 6 I2S Output

## LED Indicator

- 7 Bluetooth indicator
- 8 Signal detection indicator

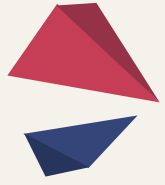

# Connection Diagram

13

POT4  
POT3  
POT2  
POT1

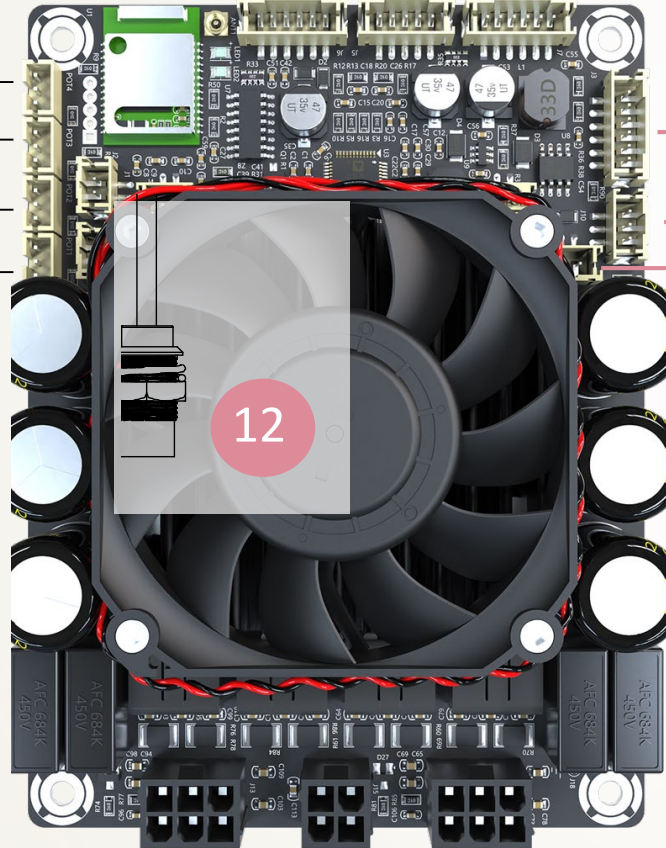

12



9

Control  
Synchronization  
Port

10



11

## Control

9

Programming

10

Control Synchronization Port

11

Standby Control

12

Bluetooth Pairing Cancellation

13

Potentiometers

SW1: Switch between Master mode and Slave mode.

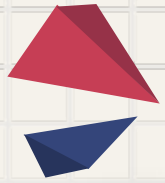

# Power Supply

Power adapter

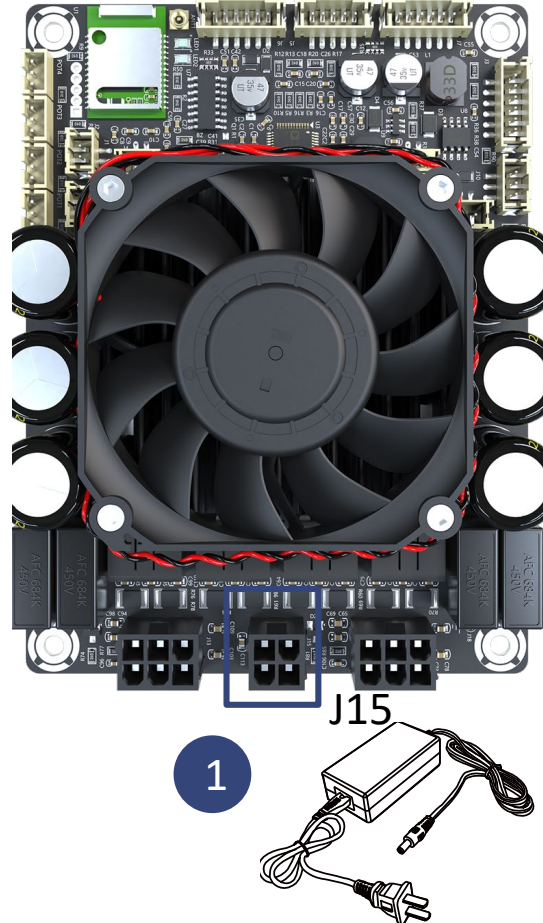

## 1, Power supply – J15

Suggested power supply should be 350W, DC36V. You can also use any power supply whose output voltage is within DC10-39V and current is higher than 4A. Please note power supply out of the recommended range may cause damage to the amplifier board.

The terminal interface used for power supply is Molex MiniFit-2x2Pos-4.2mm.

A power supply cable is the basic cable, which comes with JAB5 in the package.

# Audio Input

BT & 3.5mm AUX IN & I2S input

JAB5 supports three input methods: BT 5.0, I2S input and analog line input, which makes it suitable for various audio projects. All the signal would be mixed.

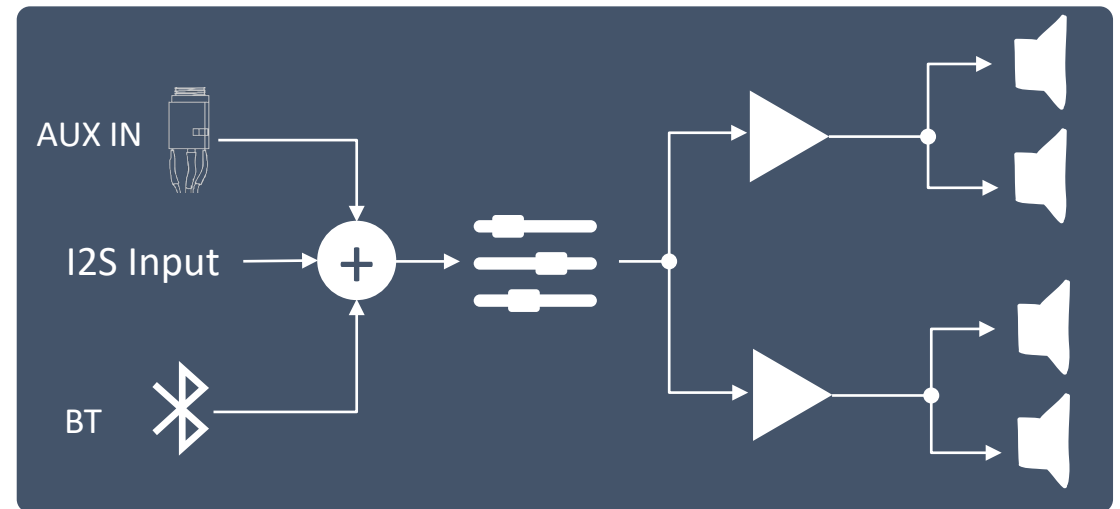
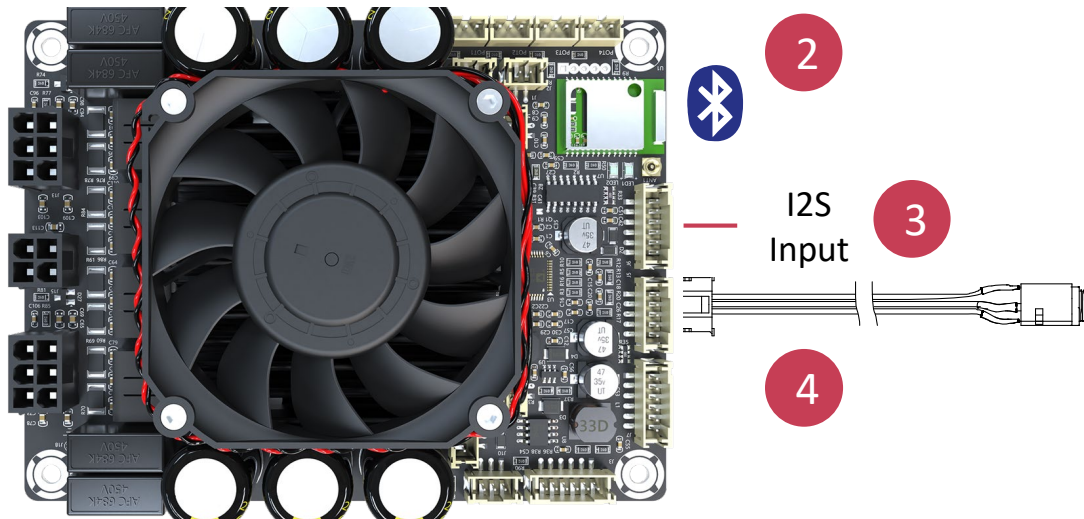



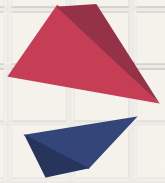

# Audio Input

Bluetooth input

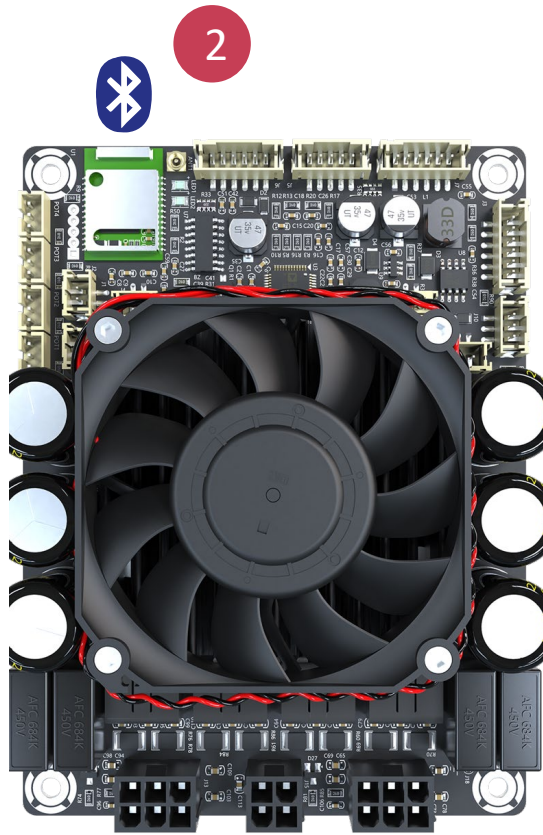

## 2, Bluetooth input

JAB5 is integrated with Bluetooth 5.0 module, supporting various audio formats as apt-X, aptX HD, apt-X LL, SBC & AAC .

There is a built-in Bluetooth antenna on the board for stable connection. So you can directly use JAB5 for audio playback.

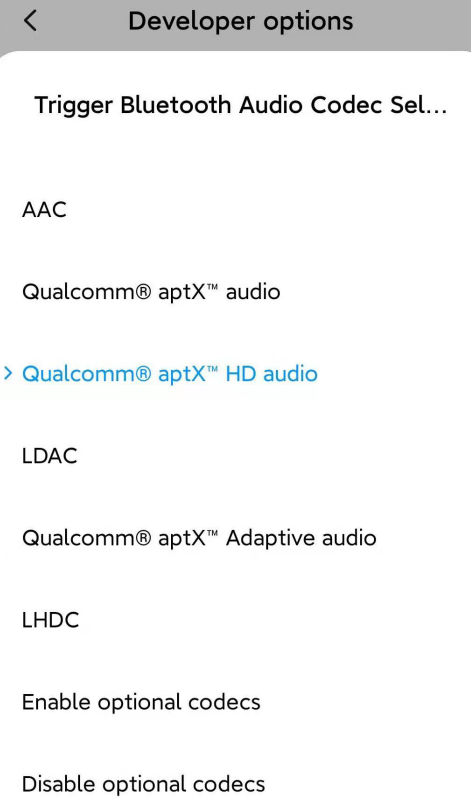

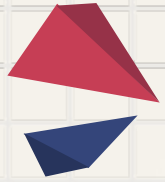

# Audio Input

Bluetooth input

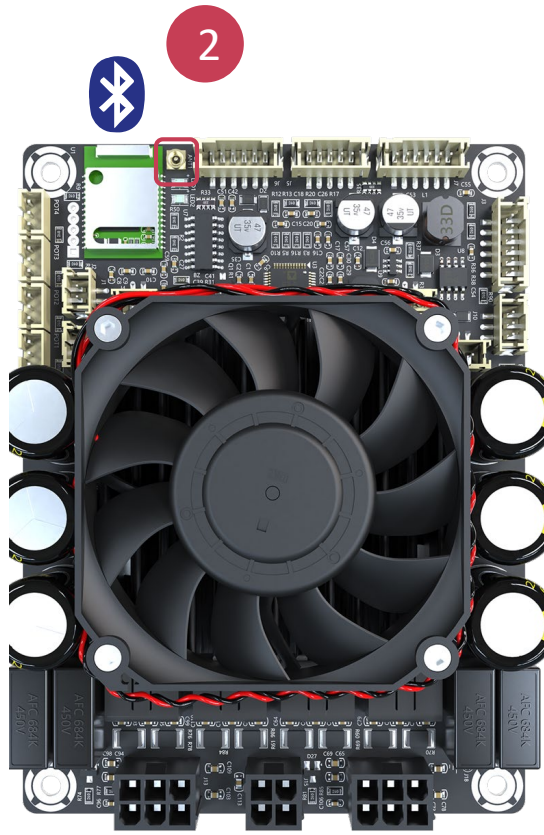

## 2, Bluetooth input

JAB5 is integrated with Bluetooth 5.0 module, supporting various audio formats as apt-X, aptX HD, apt-X LL, SBC & AAC .

An external Bluetooth antenna port is also provided, which ensures the stability even if JAB5 is installed in a cabinet.

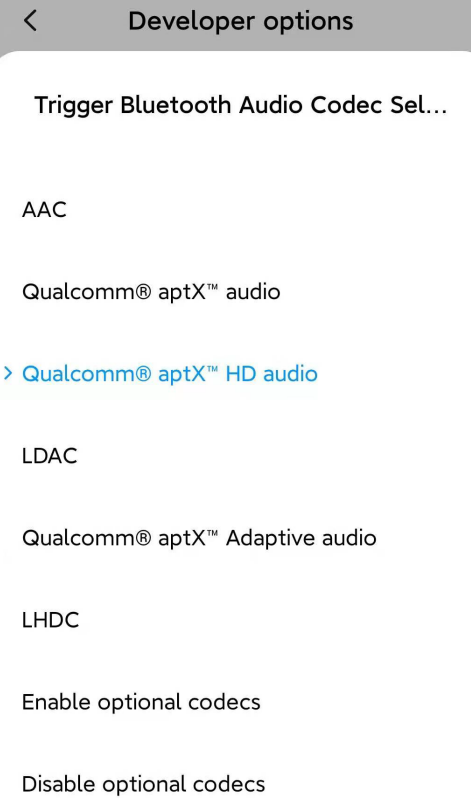

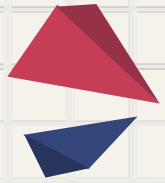

# Audio Input

3.5mm Line in & I2S input

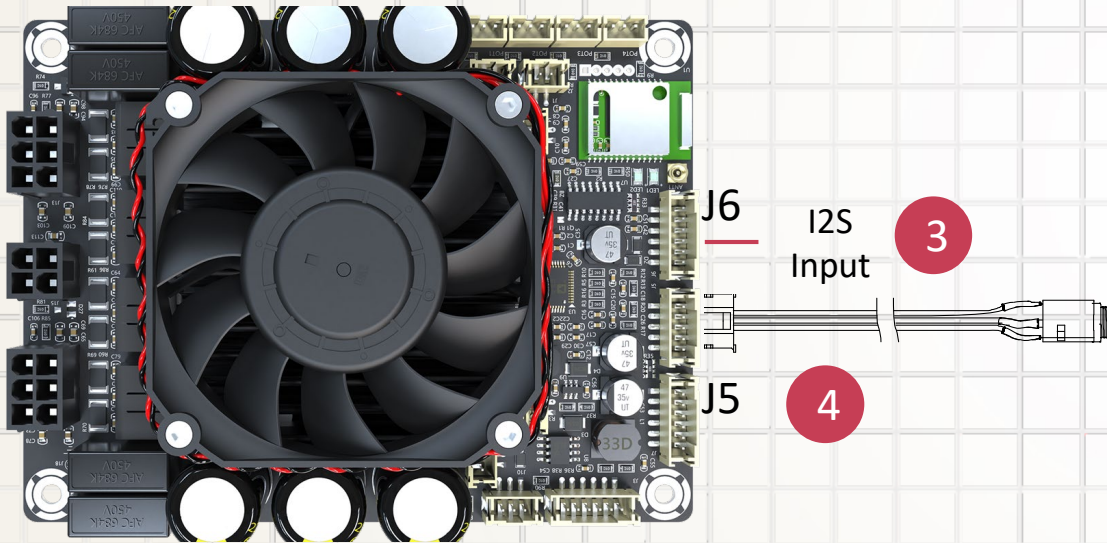

## 3, I2S Input – J6

JAB5 supports digital input as I2S input. You can find the PH-6Pos cable in the Functional Cables Kit.

## 4, Analog Line Input – J5

JAB5 supports analog input and J5 is used for 3.5mm AUX IN. You can find the 3.5mm AUX IN cable in the Functional Cables Kit.

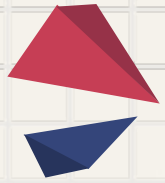

# Audio Output

Speaker output



## 5, Stereo speaker output – J13, J14

JAB5 works as 4 x 100W. It also supports configured as 2.0 / 0.2 mode (2 x 200W) or 2.1 mode (2 x 100W + 1 x 200W). The switch is achieved by automatic cables identification.

If you want to use JAB5 as 0.2 mode, you need to set frequency in the PC UI. 0.2 Mode is not supported when using hardware control.

The terminal blocks used for speaker output is Molex-MiniFit-2x3Pos-3mm.

Two speaker cables comes with JAB5 as the basic cables.

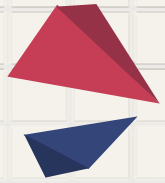

# Audio Output

Speaker output

Output Mode  
&  
Settings

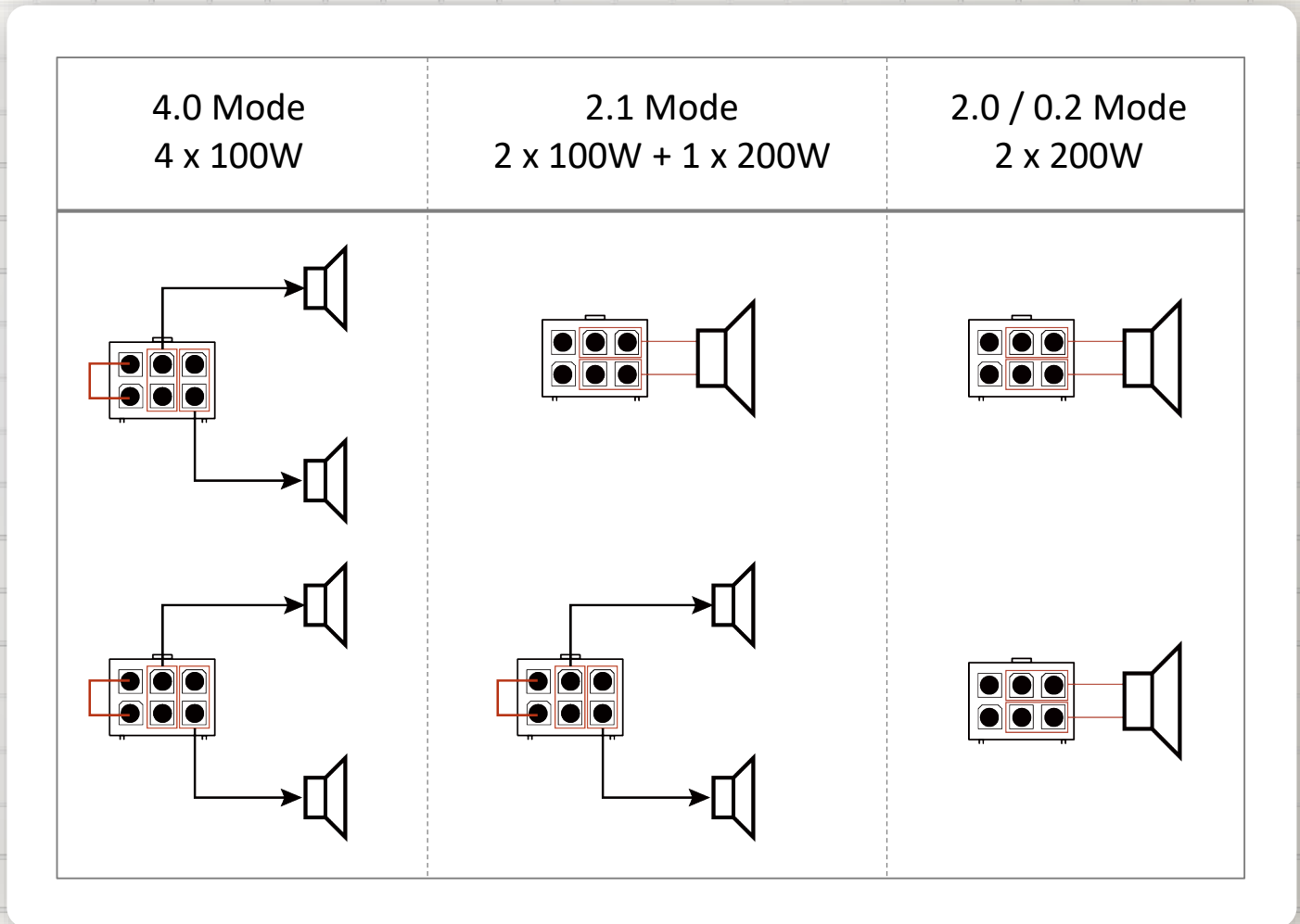

# Audio Output

I2S output

## 6, I2S output – J7

Besides speaker output, JAB5 provides I2S output, which can be transmitted into another I2S amplifier board.

You can connect JAB5 with another JAB5 to build an 8 x 100W audio system.

A switch is provided on JAB5 to set as master mode or slave mode.

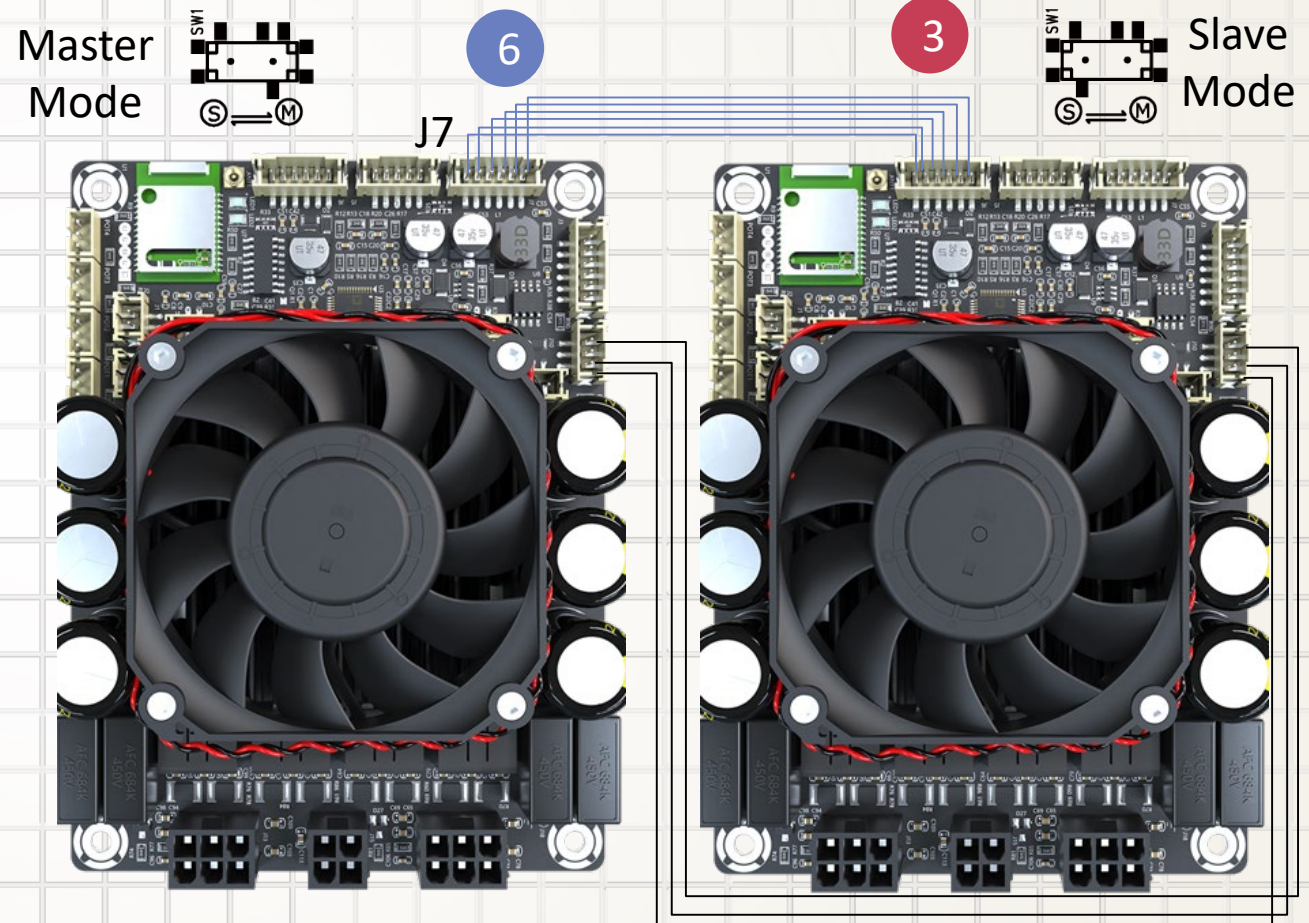

# Audio Output

I2S output

## 5, I2S output – J7

If JAB5 receives I2S from other device, it must be set as slave mode through the SW1 provided on board.

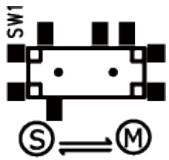

Slave Mode

If JAB5 provides I2S signal to other device, it must be set as master mode through the SW1 provided on board.

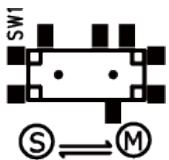

Master Mode

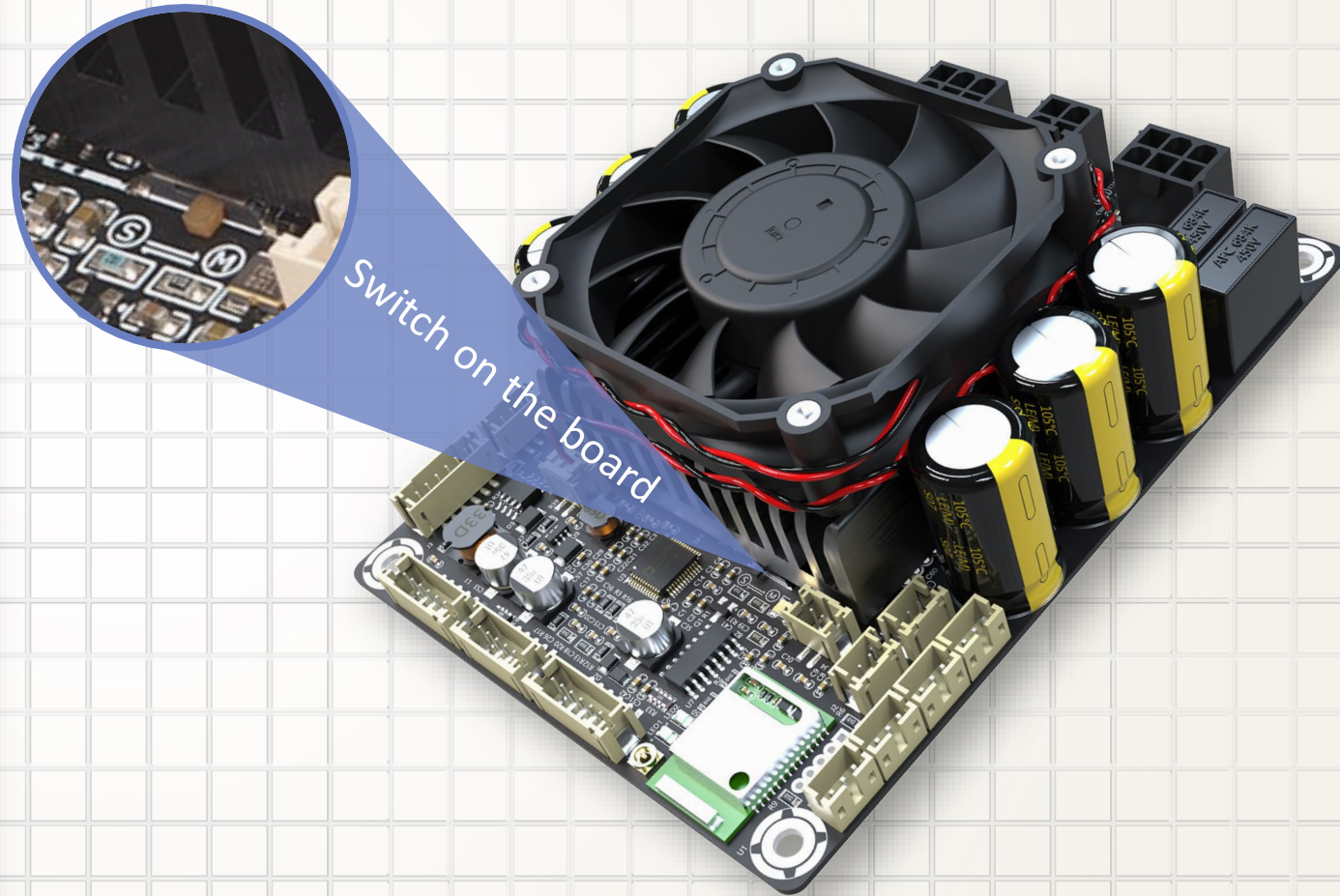

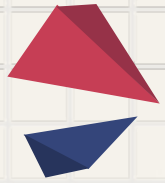

# LED Indicator

Bluetooth & Signal detection

8

Signal detection  
LED indicator



J12

7

BT LED  
indicator



J1

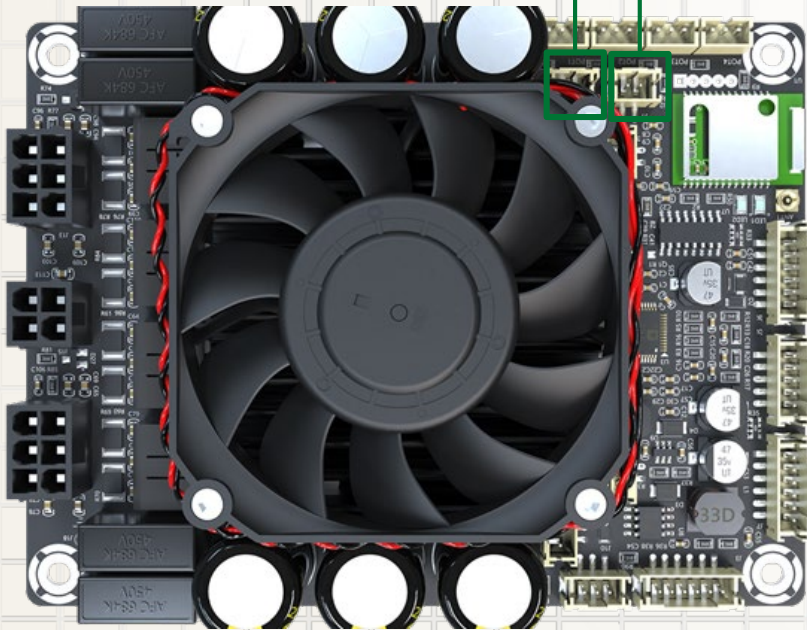

## 7, Bluetooth LED indicator – J1

When Bluetooth is paired, the LED will be ON;  
When Bluetooth is searching, the LED will BLINK.

## 8, Signal Detection LED indicator – J12

Signal level sensor system is employed in JAB5 for lower power consumption. Therefore, JAB5 provides an indicator for signal detection.

When there is signal detected, the LED will be ON;  
When there is no signal detected, the LED will be OFF.



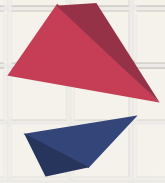

# Control

## Programming

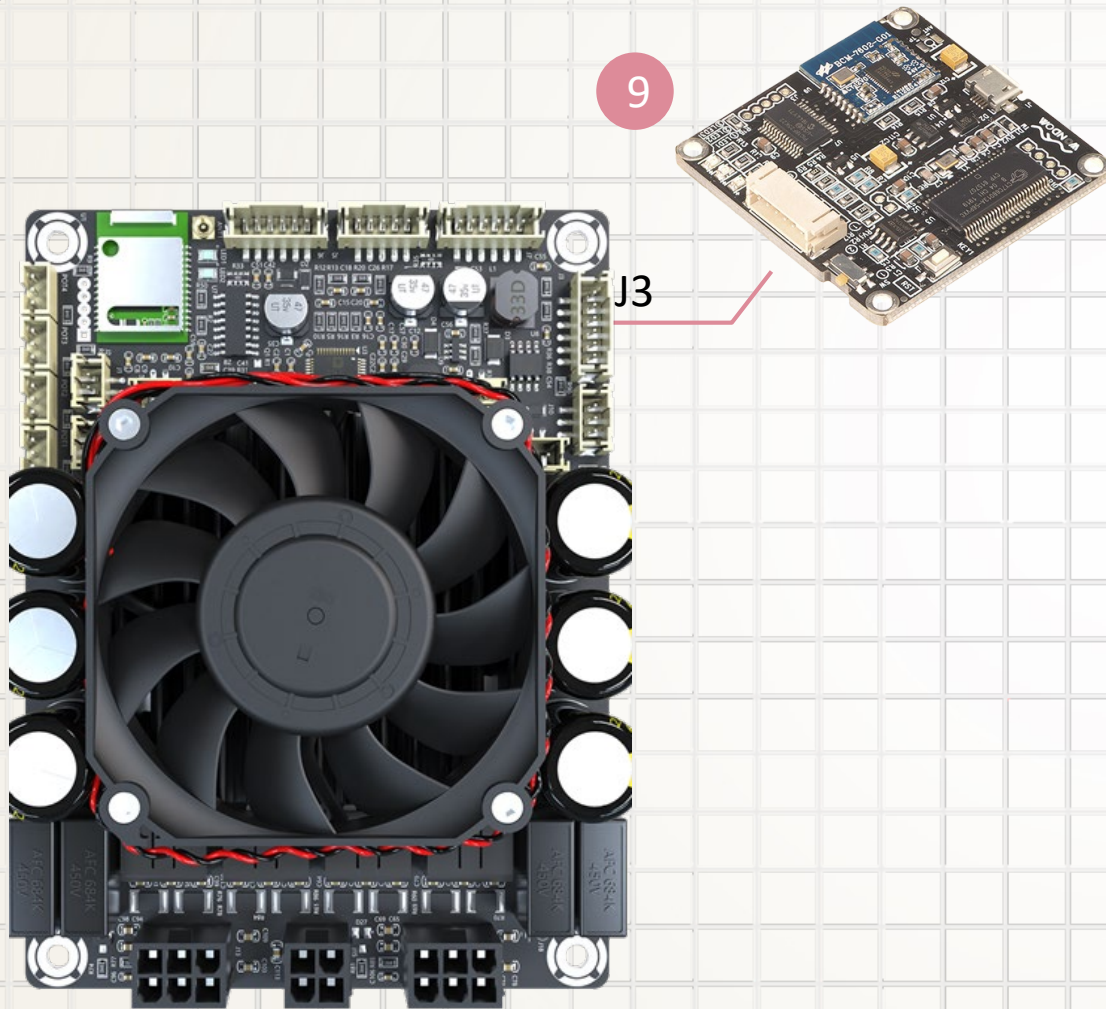

### 9, Programming – J3

Based on integrated ADAU1701 DSP, you can connect JAB5 with ICP3 or higher version(s) to get PC UI control, SigmaStudio Control or Bluetooth LE control.

You can adjust parameters of the audio system to customize your audio by any of the three methods.

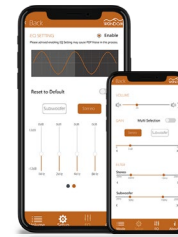
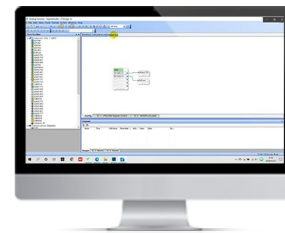

# Control

Control Synchronization Port

Master Mode

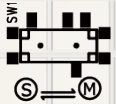

Slave Mode

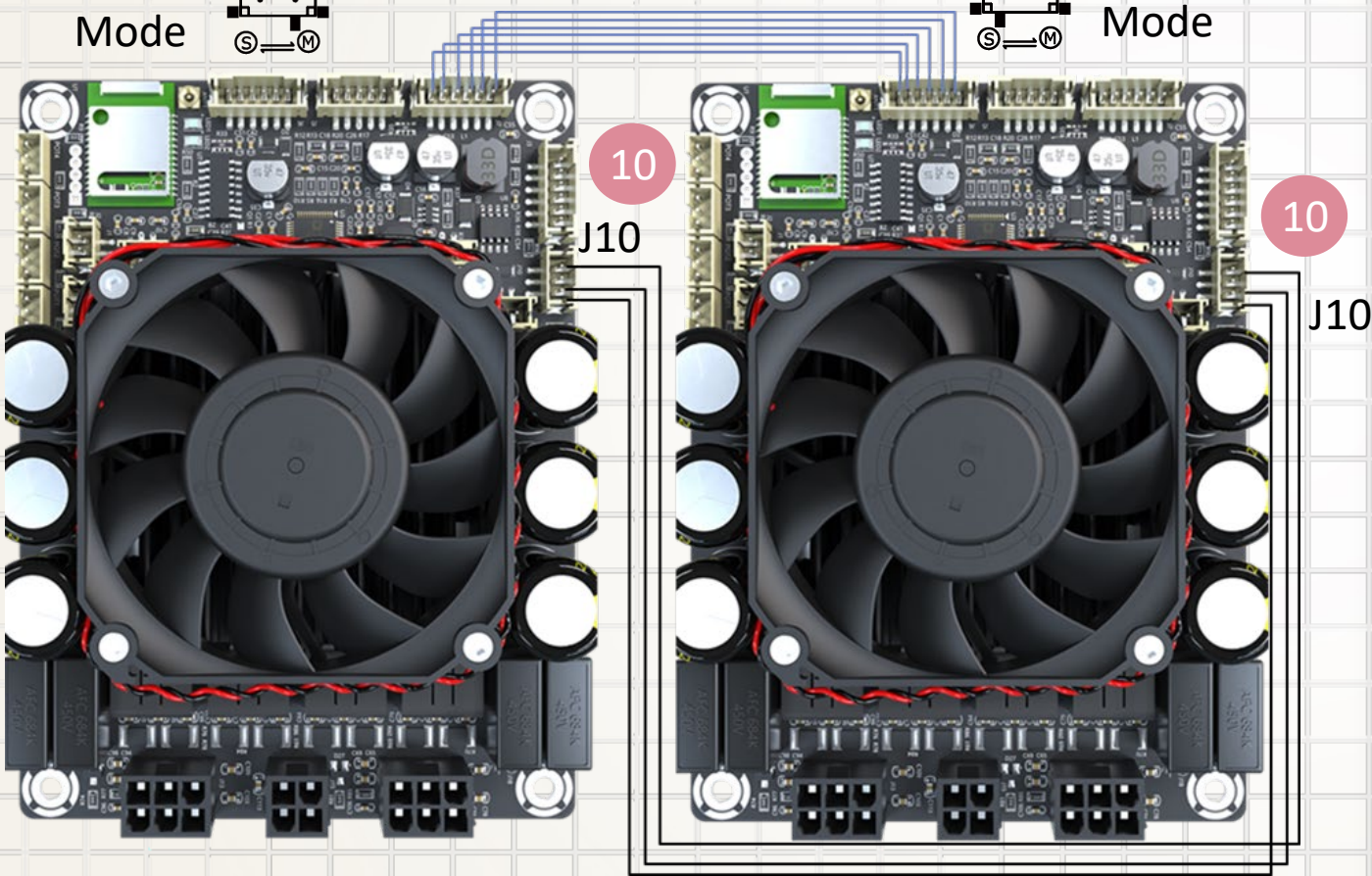
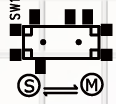

## 10, Control Synchronization Port – J10

JAB5 supports cascading with another JAB5 to get 8 x 100W or other audio systems.

This control synchronization port is provided to make sure the control logic of two connected boards are consistent, so that the built audio systems offer high quality audio and simple control.

Please do not use J10 when JAB5 is used separately.

You can find the PH-3Pos cable in the Function cables kit.

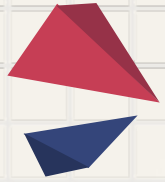

# Control

## Standby Control

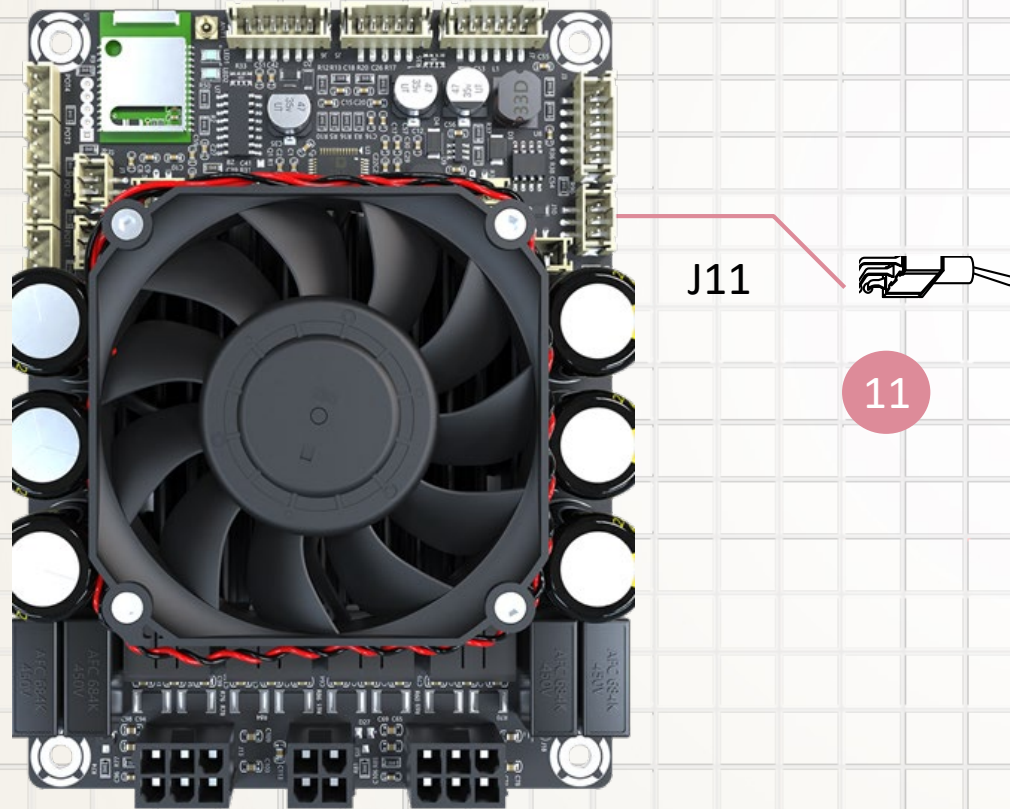

### 11, Standby Control – J11

J11 port is provided for easy control of the audio systems.

Short circuit J11, JAB5 will enter into standby mode.

Release the short circuit, JAB5 will work normally.

You can find the PH-2Pos cable in the Functional cables kit.

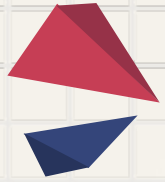

# Control

## Bluetooth Pairing Cancellation

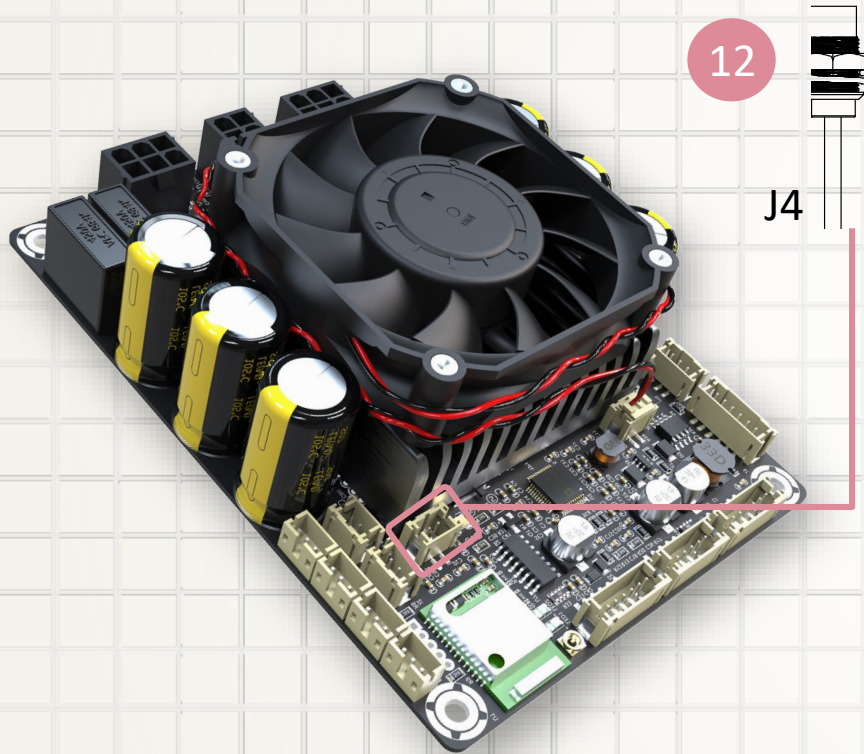

### 12, Bluetooth Pairing Cancellation Port – J4

When Bluetooth is paired, short circuit J4 to cancel pairing.

After cancellation, please release short circuit.

You can find the Bluetooth pairing cancellation cable with a button in the Functional cables kit.

When Bluetooth is paired, press the button for cancellation.



# Control

Potentiometers

13

POT4  
POT3  
POT2  
POT1



## 13, External Potentiometers

Four ports for external potentiometers are provided on JAB5 for hardware control of the whole system. You can find the cables along with potentiometers in the Functional cables kit.

**POT4: Gain of power stage channel 1**

**POT3: High-pass filter / Bandpass filter of power stage channel 1**

**POT2: High-pass filter / Bandpass filter of power stage channel 2**

**POT1: Gain of power stage channel 2**

- As for the details, please refer to the datasheet.
- If you want on-board potentiometers, please contact us. MOQ500pcs would be required.

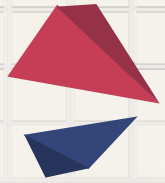

# Control

## Potentiometers

Port	Function	4.0 / 2.0 Mode	2.1 Mode (CH1 - Mono)	2.1 Mode (CH2 - Mono)
POT1	CH2 Gain	Gain of CH2	Gain of CH2	Gain of CH2
POT2	CH2 HPF or BPF	High-pass Filter of CH2	High-pass Filter of CH2	Band-pass Filter of CH2
POT3	CH1 HPF or BPF	High-pass Filter of CH1	Band-pass Filter of CH1	High-pass Filter of CH1t
POT4	CH1 Gain	Gain of CH1	Gain of CH1	Gain of CH1

### Note:

1. The channel 1 speaker output (J14) of JAB5 is defined as CH1; channel 2 speaker output (J13) is defined as CH2.
2. POT1 and POT2 are used to adjust CH2 output, POT3 and POT4 are used to adjust CH1 output. When JAB5 works as 2.1 mode, you can configure any channel as 0.1. The function of potentiometers will be changed accordingly. If you want to use JAB5 as 0.2 mode, you can set through the PC UI. Please note 0.2 mode is not available when using hardware control.
3. HPF refers to High-pass Filter; BPF refers to Band-pass Filter. When CH1 (CH2) is stereo output, the function of POT3 (POT2) is HPF; when CH1 (CH2) is mono output, the function of POT3 (POT2) is BPF.
4. For the functions of potentiometers when used in other applications, please contact us at [store@sure-electronics.com](mailto:store@sure-electronics.com).

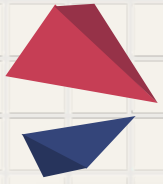

# Control

## Hardware Control

Function	Range of Frequency
High-pass Filter (4.0 / 2.0 Mode)	20Hz- 2kHz
High-pass Filter (2.0 Mode)	250Hz- 2kHz
Band-pass Filter	60Hz-120Hz (High-pass)
	200Hz-400Hz (Low-pass)

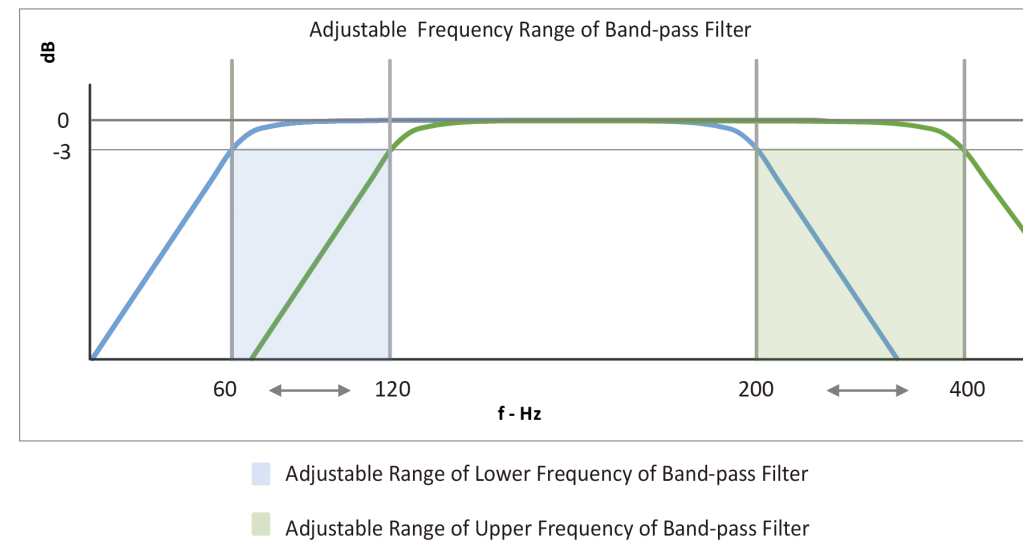
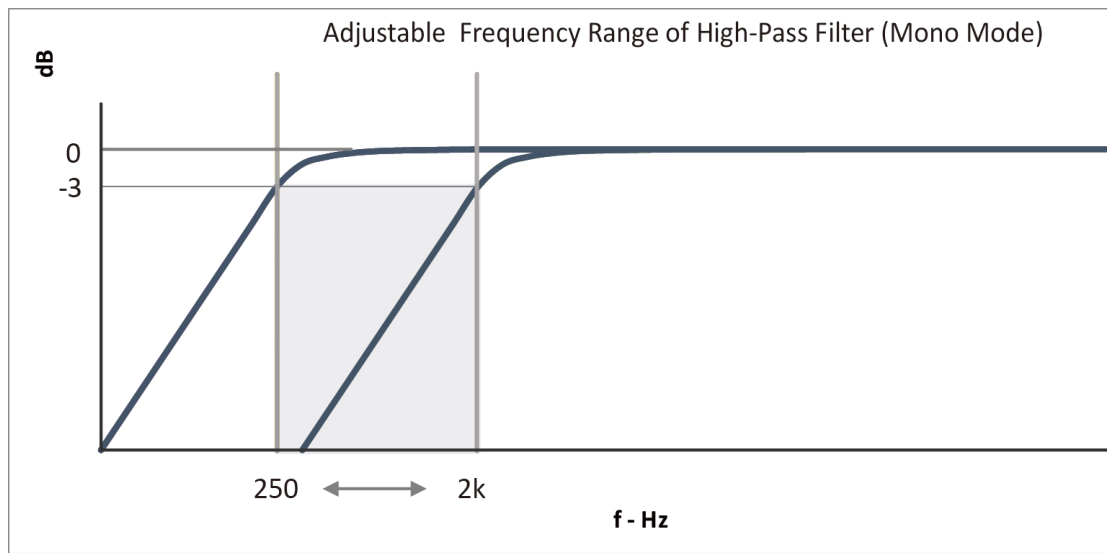

# Sure Electronics Co., Ltd.

Professional Audio Solution Provider



3F, Building F6, No. 9, Weidi Road, Xianlin, Qixia Dist., Nanjing, China

Tel: +86-025-85260046

Web: [store.sure-electronics.com](http://store.sure-electronics.com)

Email: [info@sure-electronics.com](mailto:info@sure-electronics.com)

Skype: sureelectronics



WeChat



Website



YouTube



Online Shop